

SOLINI





Solini is a Credenza collection designed to provide a storage solution for any office environment. Designed as a configurable piece, Solini can be specified to the exact requirements of the space and user. Offering a variety of finishes, colours and detailing options, the piece can subtly blend into any setting or provide a statement with contrast tones and textures.

SOLINI LOW UNIT

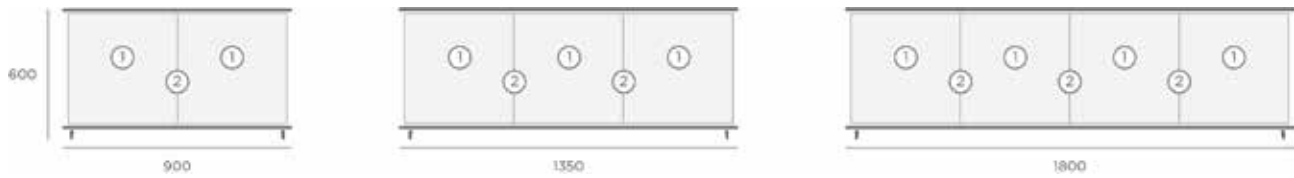

ACCESSORIES

The number in the circles represents the amount of slots the Accessory takes up in a Solini unit, as per the diagram above.

Cabinet

Low cabinets come as standard with one internal shelf. Additional shelves are available on request. Shelves are only available in plywood.

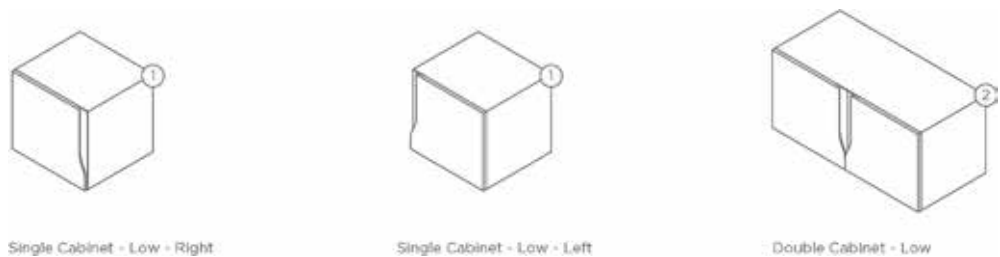

Shelf

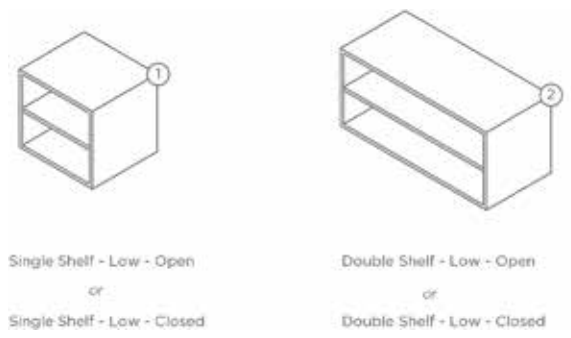

End Shelf

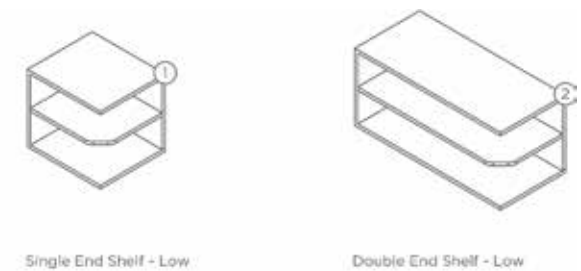

Drawer

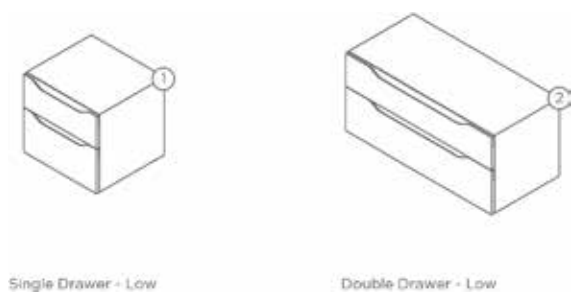

SOLINI HIGH UNIT

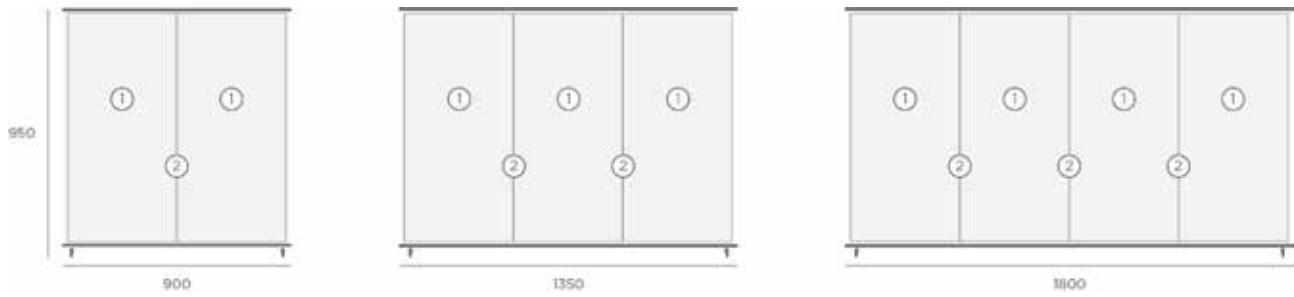

ACCESSORIES

The number in the circles represents the amount of slots the Accessory takes up in a Solini unit, as per the diagram above.

Cabinet

Low cabinets come as standard with two internal shelves. Additional shelves are available on request. Shelves are only available in plywood.

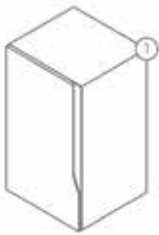

Single Cabinet - High - Right

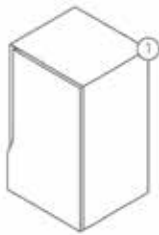

Single Cabinet - High - Left

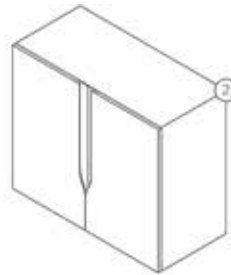

Double Cabinet - High

Shelf



Single Shelf - High - Open
or
Single Shelf - High - Closed

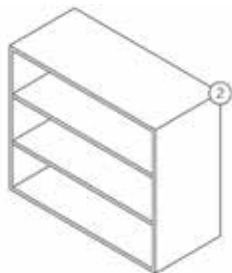

Double Shelf - High - Open
or
Double Shelf - High - Closed

End Shelf



Single End Shelf - High

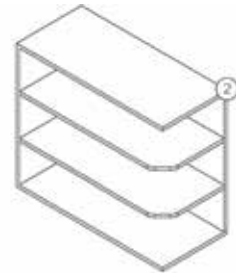

Double End Shelf - High

Drawer

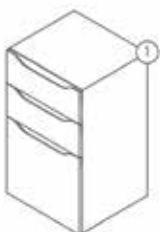

Single Drawer - High

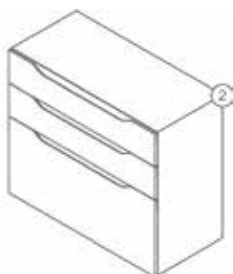

Double Drawer - High

Top & Bottom Board



Top Board - Chamfer Edge - 2



Top Board - Chamfer Edge - 3

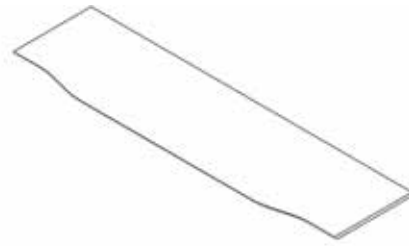

Top Board - Chamfer Edge - 4



Bottom Board - Chamfer Edge - 2



Bottom Board - Chamfer Edge - 3



Bottom Board - Chamfer Edge - 4

EDGE DETAILING



FOOT & BASE OPTIONS



CONFIGURATOR

Solini is a fully modular system. It can be tailored and configured with any of the above accessories to create the perfect credenza unit for your requirements. The units in the price list below are our standard configurations.

Visit ornfurniture.com or scan the QR code to create your unique Solini unit.



SPECIFICATIONS



Solini is part of our buy-back scheme



Solini is designed and sourced in the UK



Dimensions

Cabinet

Please note: Low cabinets come as standard with one internal shelf & high cabinets come with two.

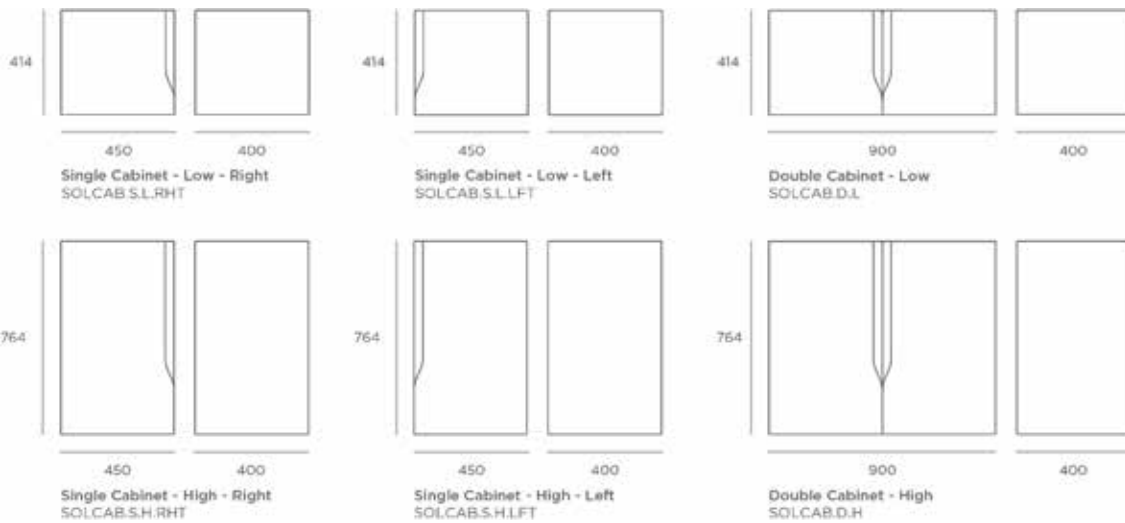

Shelf

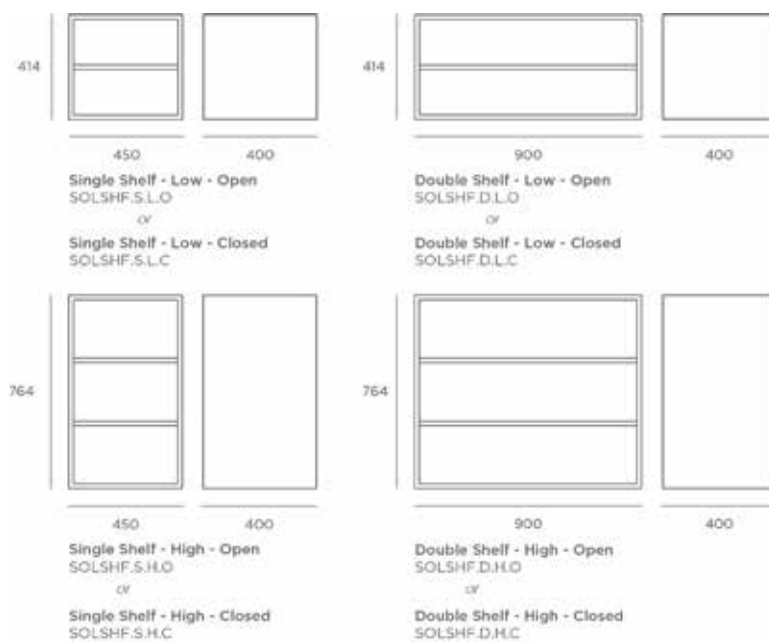

Drawer

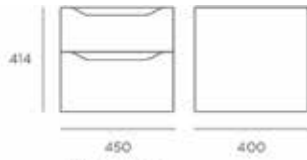

Single Drawer - Low
SOLDWR.S.L

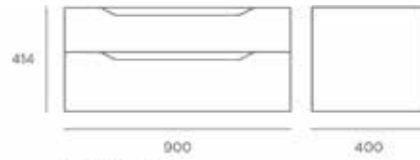

Double Drawer - Low
SOLDWR.D.L

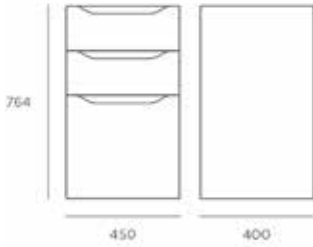

Single Drawer - High
SOLDWR.S.H

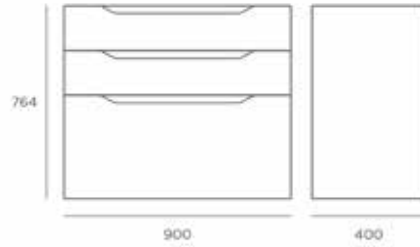

Double Drawer - High
SOLDWR.D.H

End Shelf

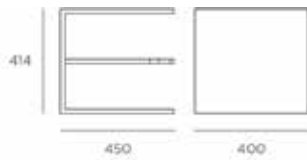

Single End Shelf - Low - Right
SOLESF.S.L.RFT

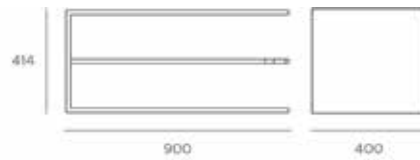

Double End Shelf - Low - Right
SOLESF.D.L.RFT

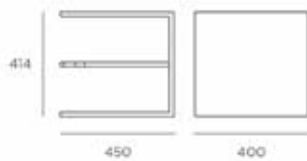

Single End Shelf - Low - Left
SOLESF.S.L.LFT



Double End Shelf - Low - Left
SOLESF.D.L.LFT

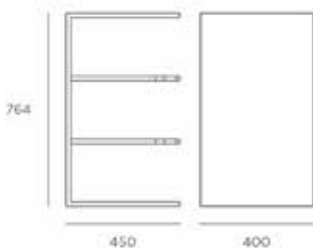

Single End Shelf - High - Right
SOLESF.S.H.RFT

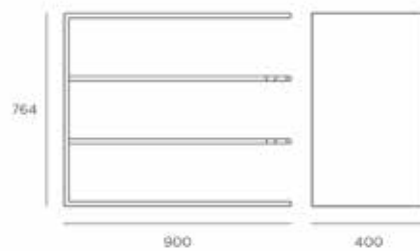

Double End Shelf - High - Right
SOLESF.D.H.RFT

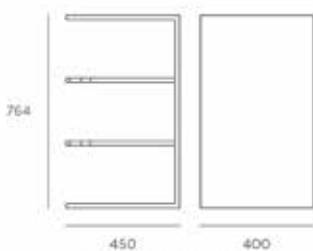

Single End Shelf - High - Left
SOLESF.S.H.LFT

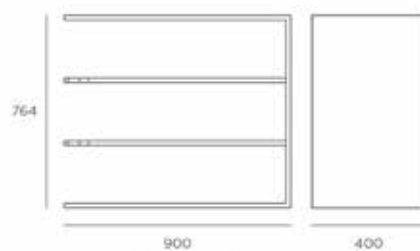

Double End Shelf - High - Left
SOLESF.D.H.LFT

Foot & Base



Top & Bottom Board

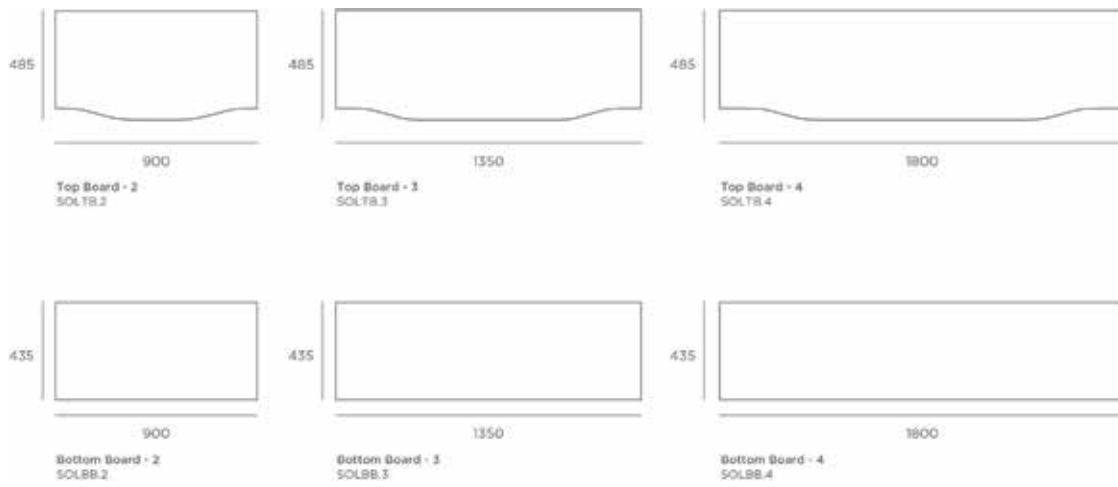

Colours & Finishes

WOODEN FOOT COLOUR OPTIONS



METAL FOOT COLOUR OPTIONS



MRMDF COLOUR OPTIONS



VENEER COLOUR OPTIONS



HANDLE FINISH OPTIONS



Sustainability*



Product Composition



Recycled content **28.2%**



Recyclable content **13.5%**

Re-usable content **86.5%**

*This sustainability information is based on the configuration in the image above and is approximate. Figures vary dependant on chosen accessories and finishes. For more detailed information contact sales@ornfurniture.com.

Product Assets & Configurator

Product Assets Folder



Configurator



Company Certifications & Accreditations

- ISO9001
- ISO14001
- ISO45001
- FSC® Certification
- FISP Membership



Design



Our Design Team approach each project with creativity and functionality at the heart of the brief. The team represent the companies' ambition to create and bring to market products of the highest quality, whilst paying close attention to the small details that make a product both memorable and distinguishable.

Based in our Banbury office, the team work with all departments within the business and our manufacturing partners to consistently deliver every piece with the original vision and direction imagined during the product's inception.

